

# CONTROL UNIT START UP PROCEDURES

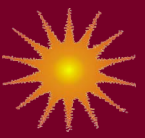

When energized, Heatizon Systems Control Units turn the primary power on and off to a step-down, low-voltage Transformer that provides power to the Heatizon Tuff Cable or ZMesh. The Control Unit can be activated by many different types of activation devices. Examples of activation devices include simple timers and thermostats, temperature and moisture sensors and telephone computer activators (see your Heatizon Systems supplier for details).

All of Heatizon System's CBX series Control Units employ "soft turn" circuits that turn the Transformer on without a high in-rush current from the power source. If there is a problem, the primary power to the Control Unit must shut OFF.

**Warning:** Make certain that any relays and circuit boards are properly seated prior to energizing the Control Unit.



**SAFETY FEATURES AND  
STARTING UP A CBX6 or  
CBX23 SERIES SYSTEM:  
GO TO PAGE 6-2 to 6-7**



**SAFETY FEATURES AND  
STARTING UP A CBX7  
SERIES SYSTEM:  
GO TO PAGE 6-8 to 6-9**



**SAFETY FEATRUES AND  
STARTING UP A RADIANT 8  
SERIES SYSTEM:  
GO TO PAGE 6-10 to 6-14**

# CBX6/23 START UP PROCEDURES

## CBX6/CBX23 SAFETY FEATURES

The following **safety circuits monitor the CBX6, CBX6T, CBX23 and CBX23T Control Units** to contribute to safe operation once the Control Unit has been started correctly:

- A. Shorting and Arcing: Monitors for loose connections between the Cold Leads and both the Transformer and the Tuff Cable or ZMesh heating element. In addition, this circuit monitors shorts and arcing on the Tuff Cable or ZMesh heating element.
- B. Overtemp Sensors: Monitors the temperature of the Transformer; in the event of the Transformer overheating, it will shut off the Transformer until it cools down, then turn it back on.
- C. Over current: If the secondary current is increased by more than 5% on ZMesh interior application systems and more than 10% on Tuff Cable systems and ZMesh snow melt and roof deicing applications, the Control Unit should shut off.
- D. Under current: If the current decreases by more than 10% on ZMesh interior application systems, and 20% on Tuff Cable systems or ZMesh snowmelt and roof deicing applications, the Control Unit should shut off.
- E. Automatic Check. The Heatizon Systems CBX6 and CBX23 Control Units automatically shut off every 30 minutes to check the power circuit for problems. If the Control Unit detects a power problems, it should shut off and keep it off.
- F. SCR Failure. The CBX6 and CBX23 has an SCR fault that opens a relay and turns the system off if the SCR fails, or if the activation device is off and the system attempts to stay on.



Note: Variation in ambient temperature will change the resistance of ZMesh and Tuff Cable. Depending upon the application and the degree of difference between the ambient temperature at the time of installation and the time of activation, the potentiometer may require fine tuning. See page 6-6 for more details.

# CBX6/23 START UP PROCEDURES

## STARTING UP A CBX6 or CBX23 SERIES SYSTEM

After all equipment is installed and electrical connections have been made the system is ready to energize and test.

The adjustment potentiometer on the Control Board for the high and low current fault circuits, must be set for the exact length of Cold Lead, Tuff Cable or Z Mesh heating element and secondary Transformer voltage. Before this can be done, the secondary current on the Transformer must be selected.

Before proceeding, make certain that all shorts have been corrected and cleared, all damaged or cut heating element and/or Cold Lead has been appropriately repaired, and any and all joints have been crimped, soldered, and tightened where appropriate,

**Step 1:** Attach a Clamp on Amp Meter around one of the Cold Leads and set the amp meter for AC Amps with a range of at least 200 Amps. Turn on the circuit breaker and switch on the activation device. System will turn on and Transformer will hum upon activation, this is normal.

**Step 2:** Check Amp Meter to see that system is running below 96 Amps. The system will operate for approximately 5 seconds if not properly adjusted. This will be long enough to get an Amperage reading from the system. If the system is not running at the expected amperage, turn the circuit breaker off, and select a different Transformer tap to achieve the proper operating amperage. Connect the Cold Lead to the newly selected tap.

**Step 3:** After readjusting the Transformer tap, switch the breaker and activation device on. System will run for another 5 seconds allowing you to recheck the Amperage measurement. Repeat this procedure until the proper operating Amperage is achieved. After the proper operating Amperage has been achieved, refer to the System Operating Tables in this Design and Installation Manual to see if Amperage compares to the calculated Amperage in in the System Operating Tables.



**WARNING:** If the proper operating amps cannot be achieved, this could indicate a fault in the installation of the heating element or other problem with the system. Consult your Heatizon dealer or Heatizon Systems for further assistance.

**NOTE:** If using an S202 or S203 dual tapped Transformer repeat the start up procedures for both the top and bottom pairs of cold leads.

# CBX6/23 START UP PROCEDURES

**Step 4:** Once the proper amperage readings have been verified you may adjust the Control Board adjustment potentiometer.

- Set the activation device to the **OFF** position (no call for heat).
- Switch the panel circuit breaker that feeds Control Unit to the **ON** position.
- Switch the breaker in the front of the Control Unit to the **ON** position.
- LED's D24 and D25 should be illuminated; this indicates line power is on with no call for heat.

**NOTE:** The Control Unit will not stay running until the Control Board is properly adjusted. Adjustment of the potentiometer must be done with the system turned on and calling for heat. The Control Unit will operate for approximately 5 seconds if not properly adjusted. When the Control Unit shuts down, it may be reset by switching the activation device or the Control Unit switch circuit breaker off and then on, then the adjustment procedure can resume.

**Step 5:** Follow the correct procedure for each specific application as described in the next few pages. There are a few additional adjustments and instructions that are unique to each application. Please locate the appropriate section for the type of system which has been installed. Refer to the Control Board diagram below to locate the adjustment potentiometer, jumpers, and LED indicators.

**NOTE:** On cold startup of all systems, the system will be slightly out of adjustment and will drift into its proper adjustment as it reaches operating temperature. Amperage will lower slightly during this warm up period; this is a normal function of the system.



## CBX6/23 CONTROL BOARD

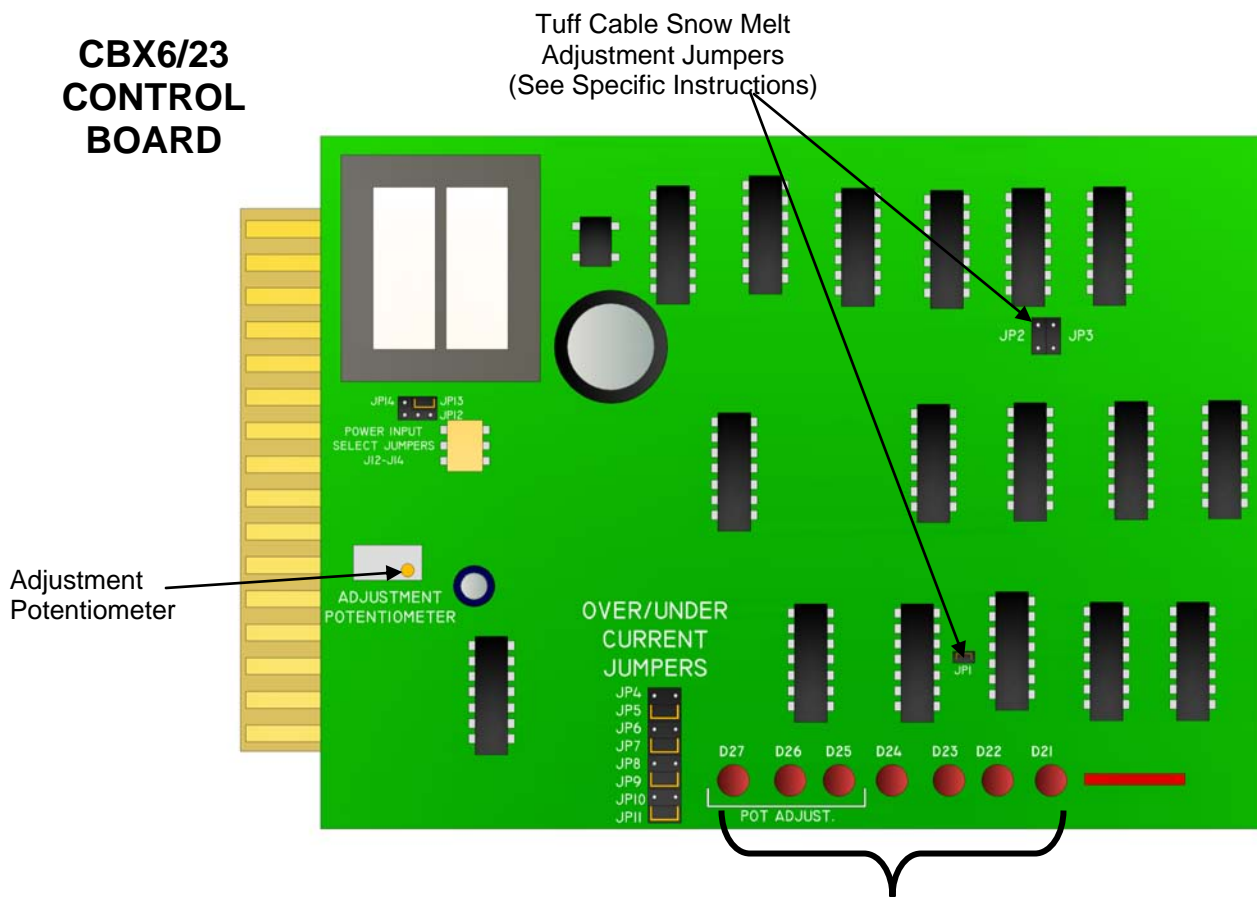

**NOTE:** LED's are designated as D21 through D27 (under current indication is D21 and over current indication is D22). LED functions are indicated on the side of the Control Unit cover. Also a status indicator is located near the other LED's on the right-hand side of the Control unit. This indicator mimics the function of the status indicator LED on the activation device.

# CBX6/23 START UP PROCEDURES

## CBX6/23 POTENTIOMETER AND JUMPER ADJUSTMENTS FOR SPECIFIC APPLICATIONS:

- 5A TUFF CABLE RETROFITS IN ASPHALT OR CONCRETE
- 5B INTERIOR ZMESH SYSTEMS AND INTERIOR TUFF CABLE SYSTEMS
- 5C Z MESH SNOW MELT AND ROOF DEICING SYSTEMS
- 5D TUFF CABLE SNOW MELT AND ROOF DEICING SYSTEMS

---

### 5A. TUFF CABLE RETROFITS IN ASPHALT OR CONCRETE:

When doing a start-up for Tuff Cable Retrofit Systems in existing asphalt or concrete, move Jumper JP1 to JP3 on the Control Board. Movement of Jumper JP1 to JP3 will cause the Control Unit to operate for approximately 120 seconds when not properly adjusted, rather than 5 seconds, to allow a longer delay before the system shuts down.

If D24 and/or D25 are on when the system is activated, turn adjustment potentiometer counter-clockwise until only D26 is lit. If LED D27 and/or D26 come on when system is activated, turn adjustment potentiometer clockwise until only D26 is lit. Let Control Unit run approximately 30 minutes for a Tuff Cable Retrofit System. If LED's D25 and/or D26 are lit, the Control Unit is adjusted correctly for the current temperature, otherwise, perform a FINAL adjustment to the potentiometer while the Tuff Cable heating element is warm. If the Control Board cannot be adjusted correctly after several attempts, turn the power off and refer to the troubleshooting section of the install manual.

---

### 5B. INTERIOR ZMESH SYSTEMS AND INTERIOR TUFF CABLE SYSTEMS

If LED's D27 and/or D26 come on when system is activated, turn adjustment potentiometer clockwise until D25 and D26 are equally lit. If D24 and D25 are lit turn the potentiometer counter clockwise until D25 and D26 are equally lit.

With the initial adjustment made let the Control Unit run for approximately 10 minutes then perform a final adjustment to the potentiometer while the heating element is warm. If the Control board cannot be adjusted correctly after several attempts, turn the power off and refer to the troubleshooting sections of the Heatizon installation manual.

---

### 5C. ZMESH SNOW MELT AND ROOF DEICING SYSTEMS

If LED's D27 and/or D26 come on when system is activated, turn adjustment potentiometer clockwise until D25 and D26 are equally lit. If D24 and D25 are lit turn the potentiometer counter clockwise until D25 and D26 are equally lit.

The temperature rise of ZMesh is less than that of Tuff Cable, primarily because of the area of the ZMesh verses the area of the Tuff Cable. As a result, while the concept is the same as with Tuff Cable, the solution is different. When installing ZMesh on a roof deicing or snow melting project the final adjustment of the potentiometer many need to be performed when the ambient temperature closely approximates the ambient temperature that will exist when the system will be energized and operating (at a temperature lower than the freezing point of 32° F and preferably when snow is on the roof, deck or other surface to be deiced or snow melted).

By secondary transformer tap selection, it may be possible to approximate a compensation for the difference between the ambient temperature at the time of installation and the ambient temperature expected at the time of operation by setting the secondary amperage down by one (1) amp for each ten (10) degrees F of expected ambient temperature decrease. For example: If the ambient temperature at the time of installation is 90° F and 30° F is the ambient temperature expected at the time of operation then the amps would be set 6 amps lower than the amps desired at the expected ambient operating temperature.

# CBX6/23 START UP PROCEDURES

## 5D. TUFF CABLE SNOW MELT AND ROOF DEICING SYSTEMS INSTALLED DURING THE SUMMER MONTHS.

Once all shorts have been corrected and cleared, all damaged or cut Tuff Cable and/or Cold Lead has been appropriately repaired, and any and all joints have been crimped, soldered, and tightened where appropriate, the following steps must be taken:

- a) Move the black jumper currently on the pins marked JP1 to the pins marked JP3 in order to change the time out period from approximately 5 seconds to approximately 120 seconds.
- b) Use the following formula to calculate the appropriate amperage setting needed to compensate for the difference between the temperature of the surface into which the Tuff Cable is embedded at the time of installation and the anticipated temperature at the time of operation.

Note: In all of our examples, 35° F is used as the anticipated or expected operating temperature during winter (at the time of operation for snow melting and roof deicing projects). You may change this to some other value if you feel the operating temperature will be different from 35°F.

Note: These formulas are a good approximation only, and as a result, it may not eliminate the need to recalibrate the system for changes in the resistance of the heating element due to temperature changes.

**Equation:**  
Set Current at Install to = 
$$\frac{\text{desired operating current (A) (Not to exceed 96 Amps)}}{\{[(\text{Element Temp @ Installation } (^{\circ}\text{F}) - 35 (^{\circ}\text{F}) \times \text{Temp Coeff}] + 1\}}$$

**Temperature Coefficient of Element:**

9" ZMesh = 0.0014

12" ZMesh = 0.0016

Tuff Cable = 0.0026

**Example:**

In this example the Desired Operating Current is 85 Amps, Element Temperature at Installation is 90°F and the element type is 12-inch ZMesh, so the Temperature Coefficient is 0.0016.

$$\text{Set Current at Install to} = \frac{85 \text{ Amps}}{\{(90-35) \times 0.0016\} + 1} = 78.125 \text{ Amps or } 78 \text{ Amps}$$

Therefore, at these conditions, the installer should target a start-up secondary current equal to 78 Amps to achieve the desired operating current of 85 Amps at 35 °F.

- c) Energize the Control Unit by turning the input power on.
- d) Set the Activator so that it is calling for the Control Unit to power the Tuff Cable heating element.
- e) Check the output amps on the secondary side of the Transformer.
- f) Set the secondary amps by changing the power tap to which the Cold Lead is connected until the amps equal the value of "set current at installation amp" in the above formula.
- g) Adjust the potentiometer of the Control Unit so that LED's D25 and D26 are evenly lit.
- h) Next use the following formula to determine the number of clockwise turns that must be made to the potentiometer in order to tune the Control Unit in for operation at the desired or anticipated operating temperature.

**(Desired Operating Current - Secondary Amps recorded at the time of installation)/ 6 = Number of Turns**

- i) Adjust the potentiometer of the Control Unit for the desired or anticipated operating temperature by turning the potentiometer clockwise the number of times calculated in the above formula.

Note: After the potentiometer of the Control Unit has been adjusted for the desired or anticipated operating temperature the system will probably turn off with an undercurrent indication (LED's D24, D25 and D21 lit). Once this happens the system is tuned in and should operate at the desired or anticipated operating temperature.

# CBX6/23 START UP PROCEDURES

**WARNING: ONCE THE CORRECT** FINAL ADJUSTMENT OF THE POTENTIOMETER HAS BEEN MADE AND THE SYSTEM HAS CORRECTLY OPERATING UNDER THE DESIRABLE CONDITIONS, THE POTENTIOMETER SHOULD NEVER NEED RE-ADJUSTMENT.

**WARNING:** NEVER READJUST THE POTENTIOMETER FOR ANY HEATIZON SYSTEM PRODUCT WITHOUT FIRST CHECKING THE OUTPUT SECONDARY CURRENT AND VERIFY THAT IT IS THE SAME AS IT WAS WHEN THE SYSTEM WAS INITIALLY SET UP AND ENERGIZED. IN THE EVENT THE OUTPUT SECONDARY CURRENT IS EVER DIFFERENT THAN IT WAS WHEN THE POTENTIOMETER WAS SET AND THAT DIFFERENCE CANNOT BE EXPLAINED BY EITHER A CORRESPONDING CHANGE IN THE PRIMARY INPUT POWER OR A CHANGE IN THE AMBIENT TEMPERATURE, A PROBLEM EXISTS AND ALL POWER TO THE SYSTEM SHOULD BE TURNED OFF UNTIL THE PROBLEM IS IDENTIFIED AND CORRECTED.

**WARNING:** Danger of shock, extreme care should be used to position Transformer taps so that they are clear of the cover or other taps on the Transformer. Carefully bend copper taps as needed to ensure proper clearance on both used and unused taps.

**Step 6:** Before installing the Control Unit cover, visually inspect the Heating Element and Cold Leads for cuts, shorts, and other damage; repair as necessary. Check for continuity to any conductive material, including but not limited to metal; eliminate as necessary. Record system information in the spaces provided on the on the Control Unit front cover. Also fill out the form Heatizon Systems "After Installation Element Test" found in the Heatizon Systems After Installation element test section of the manual. Test system in presence of Architect, Contractor and Owner's Representative, to be certain system functions in accordance with design intent.

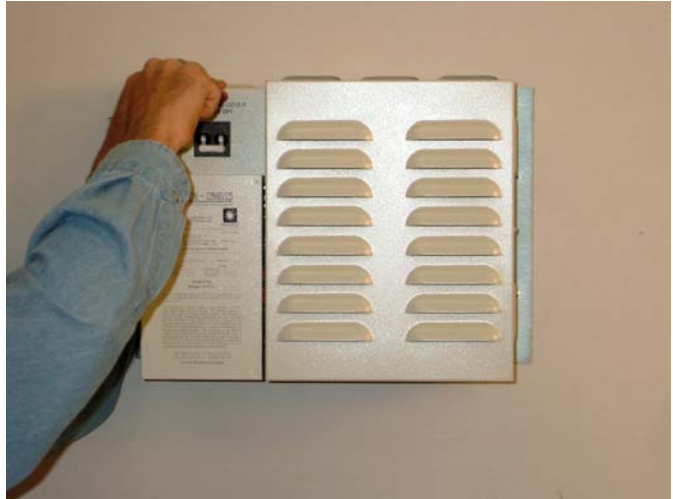

**Step 7:** After system has been properly adjusted and is running normally, the covers should be installed. Make sure to turn the system power off first, to reduce the risk of electrical shock while installing the covers.

Install Transformer cover plate first using provided #6 screws,  
Next, install Control Unit cover also using provided #6 screws.

**Step 8:** With the covers installed, energize and activate the system using the thermostat. System should operate normally. If not refer to trouble shooting section of the Heatizon Design and Installation manual. Check status indicator on side of Control Unit or activation device for solid red condition. If status LED indicates other than solid red, refer to the trouble shooting section of the install manual.

**Step 9:** Air flow around the Control Unit and Transformer is critical and must be maintained. If the Transformer overheats the Control Unit will shut the system down until the Transformer cools.

**Step 10:** The owner of the system should be given a copy of the Owner's Manual and the warranty card to be completed and returned to Heatizon Systems upon completion of the installation.

# CBX7 START UP PROCEDURES

## CBX7 SAFETY FEATURES

The following **safety circuits monitor the CBX7 Control Unit** to contribute to safe operation:

- SCR Failure. The CBX7 has an SCR fault that opens a relay and turns the system off if the SCR fails, or if the activation device is off and the system attempts to stay on.
- Use the System Operating Tables or Useful Formulas in Section 8 of this Design and Installation Manual to determine the appropriate secondary Transformer Power Tap.

## STARTING UP A CBX7 SERIES SYSTEM

The CBX7 Control Unit utilizes phase control to set the current on any given Heatizon Systems Transformer. The CBX7 incorporates a soft start that will ramp the current on and off from zero to full current in about two seconds. The soft start eliminates high in-rush current or power surge. The output current is set by adjusting a potentiometer on the Power Board, and not by using Transformer Taps.

The CBX7 has an SCR fault that opens a relay and turns the system off if the SCR fails, or if the activation device is off and the system attempts to stay on. Multiple CBX7 Control Units can be connected to a single activation device with a Selector Box (Heatizon Part # M329). Heatizon Systems offers a large number of different sized Transformers that may be used with the CBX7 Control Unit.

There is no power switch on the CBX7 assembly; the panel circuit breaker is used as the power on/off switch. A disconnect at the Transformer assembly may be desired, or required by the National Electric Code, local codes or regulations.



Before proceeding, make certain that all shorts have been corrected and cleared, all damaged or cut heating element and/or Cold Lead has been appropriately repaired, and any and all joints have been crimped, soldered, and tightened where appropriate,

**Step 1:** Visually inspect the Heating Element and Cold Leads for cuts, shorts, and other damage; repair as necessary. Check for continuity to any conductive material, including but not limited to metal; eliminate as necessary. Record system information in the spaces provided on the on the Control Unit front cover. Also fill out the form Heatizon Systems “*After Installation Element Test*” found in the Heatizon Systems After Installation element test section of the manual. Test system in presence of Architect, Contractor and Owner’s Representative, to be certain system functions in accordance with design intent.

**Step 2:** On the Power Board, turn R29 Adjustment Potentiometer (see diagram on page 6-9) counterclockwise five turns.

**Step 3.** Turn the circuit breaker ON, and/or turn the external power disconnect to the ON position.

**Step 4.** Attach a clamp-on True RMS Amp Meter to one of the Cold Leads.

**Step 5.** Turn the Activation device to the ON position

**Step 6.** Turn R29 Adjustment Potentiometer clockwise until the desired current (95 Amps or less) is achieved. Verify that the Green LED (D-7 on the Power Board) is lit when the Activation device is calling for heat.

**WARNING:** If the proper operating amps cannot be achieved, this could indicate a problem in the installation of the heating element or other problem with the system. Consult your Heatizon dealer or Heatizon Systems for further assistance.

**WARNING:** Danger of shock. Extreme care should be used to position Transformer taps so that they are clear of the cover or other taps on the Transformer. Carefully bend copper taps as needed to ensure proper clearance on both used and unused taps.



# CBX7 START UP PROCEDURES

**Step 7.** Measure the current output and voltage of the Transformer, and compare it to the System Operating Tables in this Design and Installation Manual.

**Step 8.** Measure the input current to make sure it is less than 80% of the rating of the breaker in the distribution panel. If the primary current is greater than 80% of the breaker rating, move to the next lower tap on the Transformer and readjust the potentiometer. If 80% of the circuit breaker capacity is still exceeded, call Heatizon Systems.

**Step 9:** Let the system run for a 10 minute period of time.

**Step 10:** Recheck the Amps and readjust the potentiometer if needed.

**Step 11:** Turn the activation device to the OFF position, then turn the system power OFF.

**Step 12:** Check all connections; tighten as necessary.

**Step 13:** Connect the LED Indicator Cable (pre-attached to Control Unit Cover) to the J5 terminal on the Power Board. Install the Transformer cover using provided #8 screws.

**Step 14:** With the cover installed, energize by turning the power source on, and activate the system using the activation device. Check status indicator on the front of the Control Unit. When the system is in normal operation, the Green LED is lit. If not, refer to the Trouble Shooting Section of this Heatizon Design and Installation Manual. If the Red LED is on, refer to the Trouble Shooting Section of the Heatizon Design and Installation Manual or call Heatizon Systems Technical Support Department.

**Note: Air flow around the Control Unit and Transformer is critical and must be maintained.**

**Note: The owner of the system should be given a copy of the Owner's Manual and the Warranty Card to be completed and returned to Heatizon Systems upon completion of the installation.**

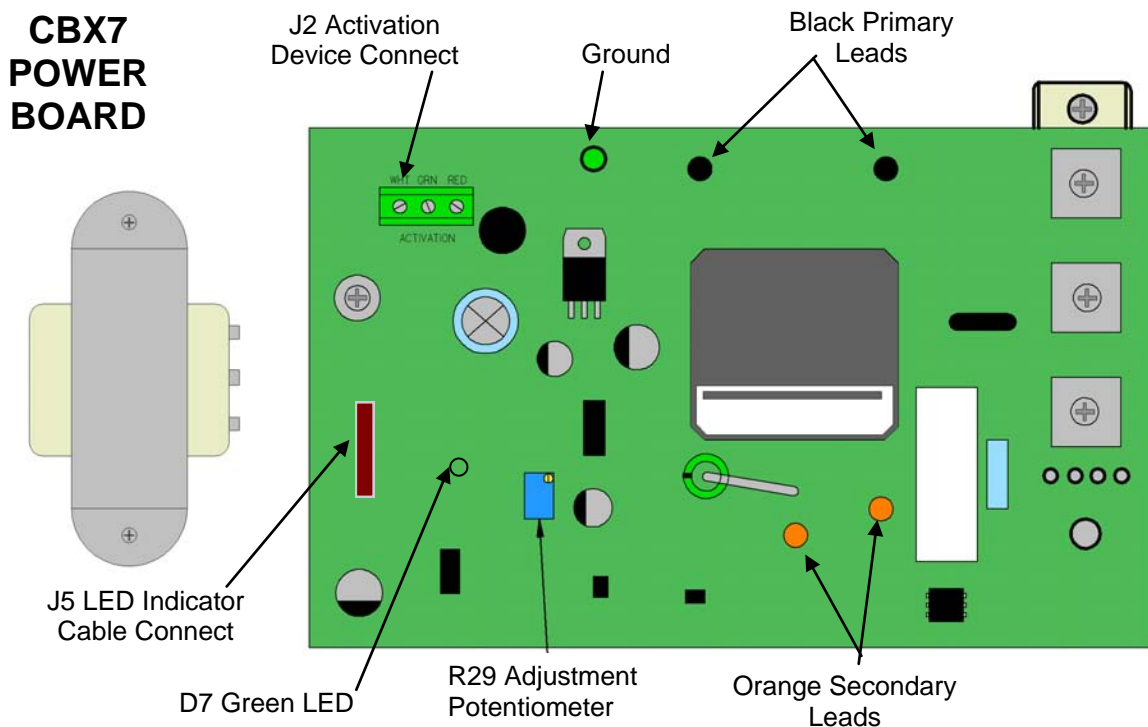

# RADIANT 8 STARTUP PROCEDURES

## RADIANT 8 CONTROL UNIT SAFETY FEATURES

When energized, Heatizon Systems' Radiant 8 Control Unit turns the primary power "on" to a step-down Transformer that provides power to the Heatizon Tuff Cable or ZMesh heating element. The Radiant 8 Control Unit can be activated by many different types of activation devices (see your Heatizon Systems Distributor for additional details on activation device alternatives).

The safety features of the Radiant 8 are designed to turn the primary power to the Transformer "off" in the event a problem is detected. Except where noted, all safety related "shut offs" must be reset by power cycling the Radiant 8 control. The Radiant 8 Control Unit has the following safety features:

**Shorting and Arcing Detection:** Each cycle of input power is monitored for current level in relation to the temperature compensated calibration setting input during the start-up procedures.. The Radiant 8 will turn the primary power to the Transformer off in the event it detects a short or arc that increases the primary current by 20% or more for 10 cycles in any one second.

**Over Temp Sensor:** In the unlikely event the Transformer temperature exceeds 100 degrees C (212 degrees F) the Radiant 8 Control Unit will turn the power supply to the Transformer "off." Once the temperature of the Transformer reduces to 75 degrees C (167 degrees F) the power supply is automatically turned back on.

**"Over Current" Detection:** The current level is checked each cycle of input power. This is compensated for temperature by using Thermister 2 which must be placed in a specific location near the heating element (see rough in instructions). If the temperature compensated current increases by 10% or more above the calibration setting, the primary power to the Transformer will be turned off.

**"Under Current" Detection:** If the compensated input current decreases by more than 10% on systems utilizing ZMesh for all applications or Tuff Cable for snow melt applications and 20% on systems using Tuff Cable Heating Element for retrofit or under roof applications, then the primary power to the Transformer will be turned off by the Radiant 8 Control Unit.

**SCR Monitor:** An SCR is a solid state switch that is used to switch the power to the Transformer. One of its failure modes is shorted. The SCR is tested periodically by the Radiant 8 Control Unit. In the event the SCR fails to turn off, an SCR fault will occur and the primary power to the Transformer will be turned off.

**Ground Fault Protection:** In the event the Tuff Cable or ZMesh Heating Element experiences a short to ground greater than 10 milliamps the Ground Fault Protection contained in the Radiant 8 Control Unit will turn the primary power to the Transformer "off."

**Temperature Compensation Thermistor:** A Thermistor is a temperature sensitive device which changes resistance proportional to temperature. Thermistor "2" monitors the temperature of the heating element environment and compensates the calibration value so that false trips do not occur. The wiring for the sensor should be run separate from the element power wherever possible to avoid coupling energy into this input.

**Power Manager:** For applications where peak electrical demand rates are in force and a system is available to monitor the total system load, the Radiant 8 has a load shed input to facilitate shedding this load from the power usage to reduce the peak demand. The Load Shed input only needs a dry contact from a relay or switch. The contacts only need to be rated for 10ma at 12 VDC. When a closed connection is sensed the system will pause and when an open connection is sensed the system will return to normal operation

**Timer Switch:** The timer switch button on the front of the Radiant 8 is designed to turn the Control Unit "on" for a controlled period of time. Push the switch once and the Radiant 8 Control Unit will energize the system for 4 hours, each subsequent push of the switch will increase the system run time by and additional 2 hours up to a maximum of 12 hours. After a few seconds, pressing the timer switch will terminate the timing sequence.

# RADIANT 8 STARTUP PROCEDURES

## RADIANT 8 MONITORING FEATURES

**DIRECTIONS FOR CONTROLLING THE SYSTEM:** Press the “Select” button to move/change categories and to save selections. Press the “Up” and “Down” buttons to select or change from options. Press both the “Up” and “Select” buttons simultaneously to move back one step.

**SYSTEM READY:** “System Ready” display indicates that there is no fault that would keep the Radiant 8 Control Unit from operating normally. Note: The safeties of the Radiant 8 monitors the primary amperes. As a result, it cannot detect cuts, nicks, and other damage to the Cold Lead, Tuff Cable, or ZMesh Heating Element.

**SYSTEM HEATING:** “System Heating” is displayed when the system is running under these conditions:

1. If the display indicates the time left on a timer, the system has been activated manually, and will show the time remaining until shut off. The timer button on the front of the Radiant 8 is designed to turn the Control Unit “on” for a controlled period of time. Push the button once and the Radiant 8 Control Unit will energize the system for 4 hours, each subsequent push of the button will increase the system run time by an additional 2 hours up to a maximum of 12 hours. After a few seconds, pressing the timer switch will terminate the timing sequence.
2. If the display indicates “Activate,” the system has been activated by an Activation device.
3. If the display indicates “Pause/Loadshed,” this means the optional loadshed input is connected and activated.

To allow for initial testing, the Radiant 8 will show NC 5:00 in the bottom line of the display when the timer is activated. This gives the installer 5 minutes to do any needed testing before a full calibration is completed. The Activation input will not function until the unit has been properly calibrated.

**SYSTEM FAULT:** If a fault shuts down the system, then the cause of the fault will be displayed until it is reset. When a fault occurs, the red LED on the thermostat will also be illuminated on activation devices that include the LED feature. Possible System Faults that may be displayed are:

High Current	Short to earth 1/2
Low Current	SCR Failures
High Trans Temp	Short or Arching
Open Temp Sensor 1/2	Cold Limit
Shorted Sensor 1/2	

Note: High Transformer temperature will occur at 100C and reset automatically at 75C. Other faults are reset by turning power off, and then on again.

Heatizon  
Radiant 8 V1.1

System Ready  
Load Area \_\_Temp

System Heating  
\_\_Time \_\_Amps

System Heating  
Activate \_\_Amps

System Heating  
Pause/Loadshed

System Fault  
High Current

Over/Under Current Settings  
ZMesh Interior (5%/10%)  
Tuff Cable (10%/20%)  
ZMesh Exterior (10%/20%)

# RADIANT 8 START UP PROCEDURES

As part of the calibration, the Radiant 8 controller will require input of data that was collected during all phases of the installation process. The necessary data should have been recorded on the inside cover of the Design and Installation manual, on the "After Element Installation Test" forms, and on the cover of the Radiant 8 Control Unit. Before beginning the start up procedures, make certain that all required data is available.

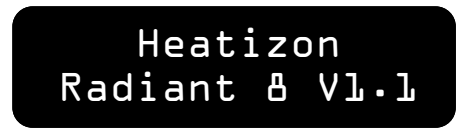

If, during the Start Up Procedure, the system is idle for a period of more than two (2) minutes, the program returns to the initial screen. Once the program returns to the initial screen, the set up procedure must be restarted.

The Model Number and version comes up when the system is powered up. During the set up procedure, press the "Up" and "Down" buttons until the correct choice or value appears in the display, then press "Select" to enter and move to the next menu item.

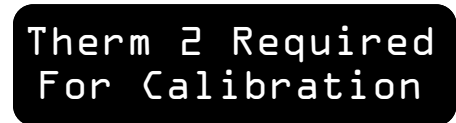

**Therm 2 Required for Calibration.** The system does not detect that Thermister 2 has been installed. Stop and recheck or repair connection before proceeding. The Thermister connection is good if this message does not appear.

**Transformer Size.** Use up and down switches to select and enter the correct Transformer installed and connected to this Radiant 8 Control Unit. Options that will display are:



- 5 kVA (Model S105)
- 2 kVA (Model S102) 6 kVA (Model S106)
- 3 kVA (Model S103) 2x2 kVA (Model S202)
- 4 kVA (Model S104) 2x3 kVA (Model S203)

**Date.** When a change is made to the setup data the date is requested. Make certain that the month, day, and year are all accurate. This will help document the setup.

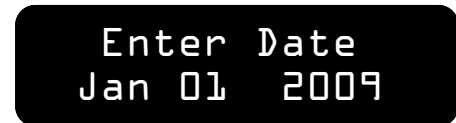

**Input Voltage.** Use up and down switches to select the appropriate primary power that is connected to the Radiant 8 Control Unit. Options that will display are:



- 208 VAC
- 240 VAC
- 277 VAC

**Load (Element Type).** This option documents the system configuration to properly calibrate the Radiant 8 Control Unit. Use up and down switches to select and enter the appropriate heating element and application that applies to this system. Options that will display are:



- ZMesh 9"
- ZMesh 12"
- Tuff Cable
- Tuff Cable Roof
- Tuff Cable Retro
- \* Note

\*Note: If you have both ZMesh and Tuff Cable in series call Heatizon Systems @ (801) 293-1232

Note: If the Radiant 8 Control Unit you are calibrating is for a dual zone system, using an S202 or S203 Transformer, you will be asked to input information for both "sides" of the Transformer. The bottom taps on the Transformer are Side 1, and the top taps of the Transformer are Side 2.

# RADIANT 8 START UP PROCEDURES

**Load Location:** Use up and down switches to select the location of the heating element. Options that will display are:

- Interior
- Exterior

The Load is \_\_\_\_\_.

**Load Length:** Use up and down switches to select the number of feet of heating element that was installed and connected to the Radiant 8 Control Unit. If heating element installed is ZMesh, "Up" and "Down" buttons allow element length of 50 to 350 feet, in 10 foot increments. If heating element installed is Tuff Cable, "Up" and "Down" buttons allow element length of 100 to 800 feet, in 10 foot increments.

Side 1 Lgth \_\_\_ft  
Folds \_\_\_#

Side 2 Lgth \_\_\_ft  
Folds \_\_\_#

**Calibrate for Folds:** If ZMesh 9" or ZMesh 12" Heating Element was selected, you will also be asked to enter the number of folds made during installation of the ZMesh. A fold is defined as each 90 degree turn.

Note: If the Radiant 8 Control Unit you are calibrating is for a dual zone system, using an S202 or S203 Transformer, you will be asked to input information for both "sides" of the Transformer. The bottom taps on the Transformer are Side 1, and the top taps of the Transformer are Side 2.

**Cold Lead Length:** Use up and down switches to select the number of feet of Cold Lead that was installed during the rough-in process and connected to the Radiant 8 Control Unit. The "Up" and "Down" buttons allow Cold Lead length of 10 to 500 feet, in 10 foot increments. Repeat this procedure for Side 2 if using an S202 or S203 Transformer.

Side 1 Cold Lead  
\_\_\_feet

Side 2 ColdLead  
\_\_\_feet

**Transformer Tap Setting:** A secondary tap suggestion for the Transformer that has been installed is displayed based on the configuration data that has been entered in. The Transformer model and secondary tap voltage should be confirmed at this time (refer to the tap voltages on the transformer label.) Press select to confirm. Repeat this procedure for Side 2 if using an S202 or S203 transformer.

Side 1 Secondary  
Tap use \_\_\_VAC

Side 2 Secondary  
Tap use \_\_\_VAC

**Transformer Mismatch:** This message will appear if the taps available on the selected Transformer do not give the appropriate voltage for the system configuration as entered.

Side 1 Mismatch  
of Trans and Load

## RADIANT 8 START UP PROCEDURES

**Load Temperature:** This display shows the current temperature of the heated area within approximately 5° (Note: Thermister 2 must be installed correctly for the load temperature to operate correctly).

Temperature of  
Load area \_\_\_F

**Audible Alarm:** An audible alarm may be selected to notify the user when a fault has occurred and the system is not functioning. Toggle between “yes” and ‘no” to indicate whether the audible alarm should sound.

Sounder with  
Alarm\_\_\_\_\_.

**Shut-Off Delay:** Depending on the application, the length of time the system will stay on after the activation device no longer calls for heat may be extended. This is especially valuable for exterior snow melt and roof de-icing systems when Mother Nature requires an operating period beyond the time that the activation device would normally have shut it off. The Shut Off Control can be programmed to delay the operating period shut off from 0 (zero) to 10 (ten) hours.

Delay to Off in  
\_\_\_Hours

**Current Amps:** Enter the Secondary Amperage readings taken with a clamp on amp meter for Side 1 and if applicable Side 2. Then press Select again. The calculated Amps, based on information input during the programming of the Radiant 8 System, is then compared to the actual secondary Amps you have entered.

Output 1 Current  
and\_\_\_Amps

Output 2 Current  
\_\_\_Amps

If there is more than a 10% disparity between these values, there is an error in the documentation. The system will still allow you to proceed and do a calibration if you determine that the setup is correct.

Calc Amps1 =\_\_.  
Act Sec Amps\_\_.

**Calibration Delay:** The system is now ready to perform calibration and system start up. The standard delay before calibration is 1 minute, and you will be asked to confirm that you are ready for the Radiant 8 to calibrate. Press the “Up” button to begin calibration. A countdown timer will appear, counting down to the calibration. Pressing select at this point takes you to the next menu item instead of doing a calibration.

Do Calibration  
in 1 minute?

Delay to Calib.  
In \_\_\_sec

**Viewing Angle.** If the Radiant 8 Control Unit is mounted above eye level, you may wish to adjust the viewing angle and contrast of the read out display for enhanced viewing. The viewing angle and contrast can be adjusted from 0 to 10. This will not be needed for most applications.

LCD adjust for  
Viewing Angle 05